

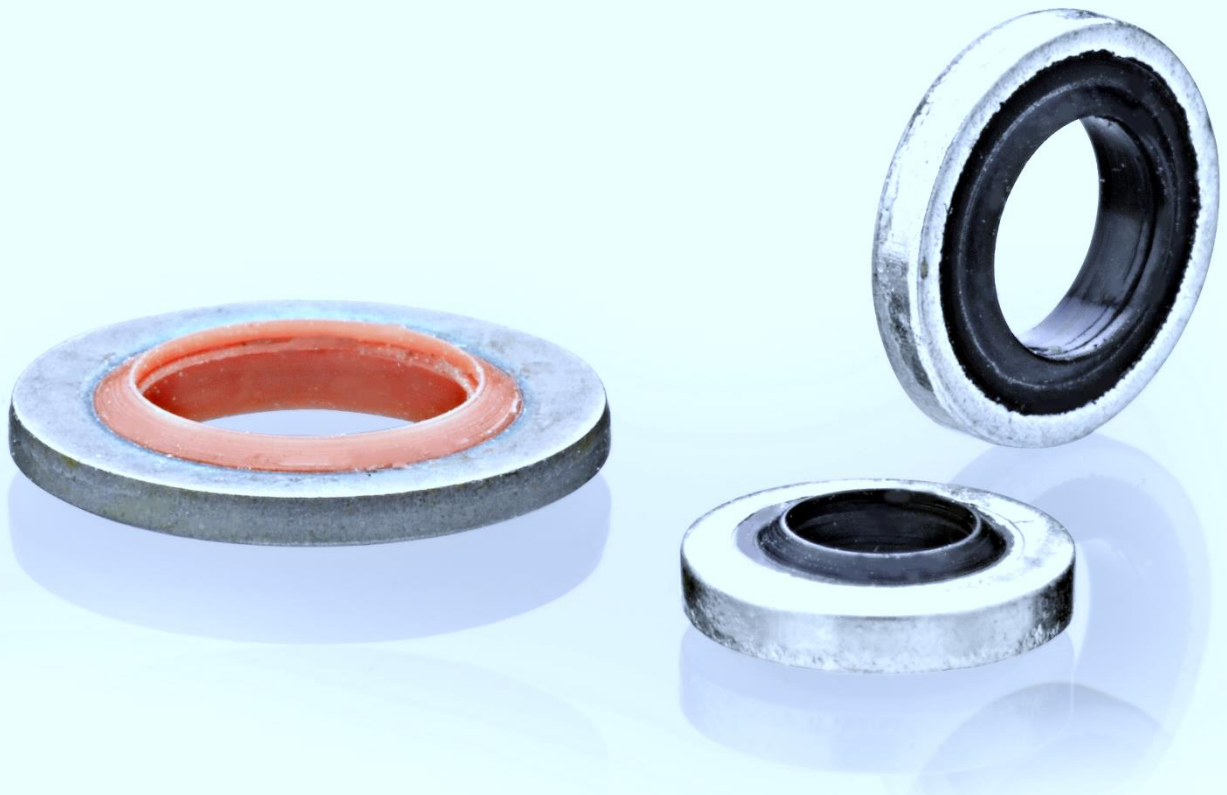

HOFFMANN

vor-teil. form. spezialitäten.



Standardteile

Schraubenkopf- dichtung

Schraubenkopfdichtungen bzw. Bonded Seals werden als Standardelemente zur Abdichtung von Schraubenverbindungen mit planen Oberflächen verwendet. Sie bestehen aus einer **Unterlegscheibe** und einer **anvulkanisierten Dichtung**, welche Schraubenverbindungen und Befestigungselemente abdichten. Die Schraubenkopfdichtungen sind für metrische als auch für Whitworth Gewinde verfügbar.

Der max. Betriebsdruck ist von der Dichtungsgeometrie, den Abmessungen und der Werkstoffauswahl abhängig. Schraubenkopfdichtungen sind bis zu einem Betriebsdruck von 200 MPa einsetzbar.

Je nach gewähltem Compound liegen die Betriebstemperaturen zwischen -50 und + 200 °C.

Nutzen Sie die Vorteile der Bonded Seals von HOFFMANN:

- Einfache Montage
- Kostengünstige Dichtungslösung
- Wiederverwendbar
- Für die meisten Schraubenarten, Flansche und Ansenkungen geeignet
- Kontrollierte Verpressung durch Metallscheibe
- In verschiedenen Metallausführungen (Stahl, Edelstahl, Messing, Aluminium) erhältlich
- In unterschiedlichsten Elastomervarianten (EPDM, NBR, FPM, etc.) erhältlich
- Sichere Abdichtung bei niedrigen und hohen Drücken

Sie können unsere **Bonded Seals** als Standardware oder auch als kundenspezifisch hergestellte Schraubenkopfdichtungen bestellen.

Ihr Ansprechpartner:



Jochen Kugler

GF Vertrieb/Sales

j.kugler@hofftech.com

Tel. (+49)-(0)7021 95010-12

Fax (+49)-(0)7021 95010-55

small is beautiful - Mikroverbundteile von Hoffmann

Schraubenkopfdichtung Typ BS
Bonded Seal Typ BS

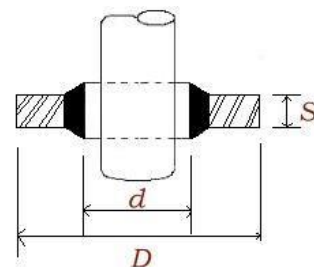

ID (d)	AD (D)	H (s)	Artikel
3.05	6.35	1.20	BS001
3.60	7.50	1.00	BS301
4.10	7.20	1.00	BS201
4.12	7.26	1.20	BS002
4.50	7.00	1.00	BS202
4.60	9.00	1.00	BS302
5.21	8.38	1.20	BS003
5.60	10.00	1.00	BS303
5.70	9.00	1.00	BS203
5.70	10.00	1.00	BS204
6.20	9.20	1.00	BS205
6.60	11.00	1.00	BS304
6.70	10.00	1.00	BS206
6.70	11.00	1.00	BS207
6.70	11.00	2.50	BS208
6.85	13.27	1.30	BS305
6.86	13.21	1.20	BS004
6.99	13.34	1.20	BS005
7.00	11.40	1.00	BS306
7.10	12.00	1.00	BS209
7.30	10.20	1.00	BS210
8.30	12.70	1.20	BS519
8.31	13.34	1.20	BS006
8.50	13.40	1.00	BS211
8.60	13.00	1.00	BS307
8.64	14.22	1.20	BS007
8.70	13.00	1.00	BS212
8.70	14.00	1.00	BS213
8.70	16.00	1.00	BS214
9.30	13.30	1.00	BS215
10.35	16.00	2.00	BS216
10.37	15.88	2.00	BS020
10.40	14.77	1.20	BS510
10.70	16.00	1.50	BS217

ID (d)	AD (D)	H (s)	Artikel
10.70	18.00	1.50	BS218
10.70	17.00	1.50	BS310
11.26	18.36	2.00	BS008
11.40	16.30	1.50	BS219
11.69	19.05	2.00	BS009
11.80	18.50	1.50	BS220
11.80	19.10	1.50	BS221
11.80	18.10	1.50	BS312
12.70	18.00	1.50	BS222
12.70	20.00	1.50	BS223
12.70	19.00	1.50	BS313
13.70	20.00	1.50	BS224
13.70	22.00	1.50	BS225
13.74	20.57	2.00	BS021
13.80	20.10	1.50	BS315
13.85	18.70	1.20	BS511
14.00	18.70	1.50	BS226
14.70	22.00	1.50	BS227
14.70	21.00	1.50	BS316
14.86	22.23	2.00	BS010
15.83	22.23	2.00	BS022
16.00	22.70	1.50	BS228
16.51	25.40	2.00	BS011
16.70	24.00	1.50	BS229
16.70	23.00	1.50	BS317
17.20	23.90	2.00	BS319
17.28	23.80	2.00	BS023
17.35	22.70	1.20	BS512
17.40	24.00	1.50	BS230
18.00	24.70	1.50	BS231
18.16	25.40	2.30	BS012
18.70	26.00	1.50	BS232
18.70	27.00	2.00	BS320
19.69	26.92	2.30	BS024

small is beautiful - Mikroverbundteile von Hoffmann

Schraubenkopfdichtung Typ BS
Bonded Seal Typ BS

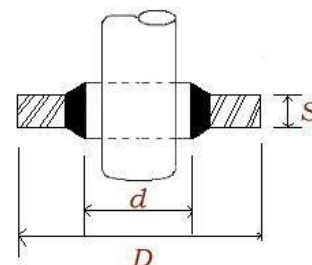

ID (d)	AD (D)	H (s)	Artikel
20.70	28,00	1,50	BS233
20.70	29,00	2,00	BS321
21.50	28,70	2,50	BS234
21.54	28,58	2,50	BS025
21.65	26,70	1,20	BS513
22.50	28,00	1,50	BS235
22.70	30,00	2,00	BS236
22.70	30,00	3,00	BS237
22.70	31,00	2,00	BS324
23.49	31,75	2,30	BS026
23.70	32,00	2,00	BS325
24.26	33,27	2,30	BS013
24.70	32,00	2,00	BS238
24.70	33,00	2,00	BS326
26.70	35,00	2,00	BS239
27.00	35,30	2,00	BS327
27.05	34,93	2,30	BS027
27.05	34,93	2,50	BS027
27.20	36,00	2,00	BS240
27.30	32,50	1,20	BS514
27.30	32,60	2,00	BS520
27.70	36,00	2,00	BS328
27.82	38,61	2,30	BS028
28.6	36,00	2,00	BS329
28.7	37,00	2,00	BS241
29.2	37,50	2,00	BS330
29.33	36,58	2,30	BS014
30.7	39,00	2,00	BS331
30.81	38,10	2,30	BS029
31.00	39,00	2,00	BS242
32.64	41,40	3,20	BS015
33.70	42,00	2,00	BS243
33.70	42,00	2,00	BS332
33.89	42,80	3,20	BS030

ID (d)	AD (D)	H (s)	Artikel
33.89	42,80	2,30	BS031
34.20	39,50	2,00	BS515
34.30	43,00	2,00	BS244
35.94	44,45	3,20	BS016
36.70	46,00	2,00	BS245
37.00	48,00	2,50	BS333
38.96	47,75	3,20	BS017
40.00	51,00	2,50	BS246
40.00	51,00	2,50	BS334
42.70	53,00	3,00	BS247
42.80	49,50	2,00	BS516
42.93	52,38	3,20	BS032
43.00	54,00	2,50	BS335
45.34	57,15	3,20	BS018
46.00	57,00	2,50	BS336
48.44	58,60	3,20	BS033
48.70	59,00	3,00	BS248
48.70	55,50	2,00	BS517
49.00	60,00	2,50	BS337
51.69	63,50	3,20	BS019
52.00	60,00	3,00	BS249
53.30	64,50	3,00	BS250
54.89	69,85	3,20	BS034
58.04	70,36	3,20	BS035
60.50	68,50	2,00	BS518
60.58	73,03	3,20	BS036
60.70	73,00	3,00	BS251
64.39	77,22	3,20	BS037
66.68	79,50	3,20	BS038
68.60	79,50	3,50	BS252
76.08	90,17	3,20	BS039
76.08	90,30	3,50	BS253
89.09	101,48	3,20	BS254
127.00	143,67	5,00	BS255

small is beautiful - Mikroverbundteile von Hoffmann

Selbstzentrierende Schraubenkopfdichtung Typ SCR
Bonded Seal Self Centering Typ SCR

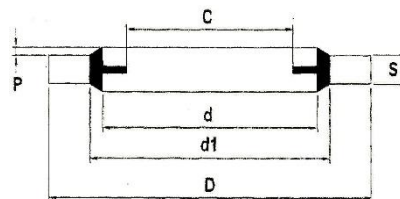

d	C	d1	D	S	P	Artikel
4,50	3,40	5,40	7,00	1,0	0,30	SCR202
5,70	4,50	6,80	9,00	1,0	0,30	SCR203
6,60	4,70	8,00	11,00	1,0	0,30	SCR304
6,70	4,70	8,00	10,00	1,0	0,40	SCR206
6,70	4,70	8,20	11,00	1,0	0,30	SCR207
8,60	6,30	10,20	13,00	1,0	0,50	SCR307
8,70	6,40	10,00	13,00	1,0	0,30	SCR212
8,70	6,40	10,40	14,00	1,0	0,30	SCR213
10,37	8,26	11,84	15,88	2,0	0,20	SCR020
10,70	8,05	12,40	16,08	1,5	0,40	SCR217
12,70	9,50	14,40	18,00	1,5	0,38	SCR222
12,70	9,73	14,10	19,00	1,5	0,30	SCR313
13,70	10,00	15,30	22,00	1,5	0,40	SCR225
13,74	11,18	15,21	20,57	2,0	0,20	SCR021
14,70	11,38	16,40	22,00	1,5	0,40	SCR227
16,51	12,90	18,75	25,40	2,0	0,20	SCR011
16,70	13,41	18,40	24,00	1,5	0,40	SCR229
17,28	14,76	18,75	23,80	2,0	0,20	SCR023
18,16	14,50	19,69	25,40	2,5	0,25	SCR012
18,70	14,76	20,40	26,00	1,5	0,40	SCR232
20,70	16,76	22,50	28,00	1,5	0,40	SCR233
21,54	18,24	23,01	28,58	2,5	0,25	SCR025
22,70	18,74	24,40	30,00	2,0	0,40	SCR236
23,49	20,27	24,97	31,75	2,5	0,25	SCR026
24,70	20,11	26,40	32,00	2,0	0,40	SCR238
26,70	22,80	28,40	35,00	2,0	0,40	SCR239
27,05	23,83	28,53	34,93	2,5	0,25	SCR027
27,70	23,30	29,40	36,00	2,0	0,40	SCR328
30,81	27,51	32,29	38,10	2,5	0,25	SCR029
33,89	29,92	36,88	42,80	3,2	0,25	SCR030
36,70	31,80	38,80	46,00	2,0	0,40	SCR245
42,93	38,45	45,93	52,38	3,2	0,25	SCR032
48,44	44,45	51,39	58,60	3,2	0,25	SCR033
54,89	50,42	58,30	69,85	3,2	0,25	SCR034

small is beautiful - Mikroverbundteile von Hoffmann

d	C	d ₁	D	S	P	Artikel
60,58	56,26	63,63	73,03	3,2	0,25	SCR036
66,68	62,36	69,98	79,50	3,2	0,25	SCR038
76,08	71,50	79,38	90,17	3,2	0,25	SCR039
89,09	84,50	92,10	101,35	3,25	0,35	SCR254

Selbstzentrierende Schraubenkopfdichtung Typ GM1000
Bonded Seal Typ GM1000

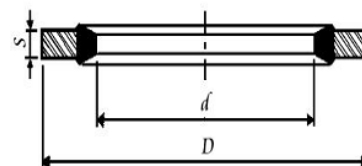

ID (d)	AD (D)	H (s)	Artikel
4	8	1.0	GM 4
5	9	1.0	GM 5
6	10	1.0	GM 6
7	11	1.0	GM 7
8	13	1.0	GM7,5
8	14	1.0	GM 8
10	17	1.5	GM 10
10	18	1.5	GM 11
12	19	1.5	GM 12
14	22	1.5	GM 14
16	24	1.5	GM 16
18	27	1.5	GM 18
18	26.5	2.0	GM 18

ID (d)	AD (D)	H (s)	Artikel
20	30	2.0	GM 20
22	32	2.0	GM 22
26	35	2.0	GM 23
24	36	2.0	GM 24
27	41	2.0	GM 27
30	46	2.0	GM 30
33	50	2.5	GM 33
36	55	2.5	GM 36
39	60	2.5	GM 39
42	65	2.5	GM 42
45	70	3.0	GM 45
48	75	3.0	GM 48
52	80	3.0	GM 52

Selbstzentrierende Dichtscheibe Typ GMS
Bonded Seal Typ GMS Sealing Washer

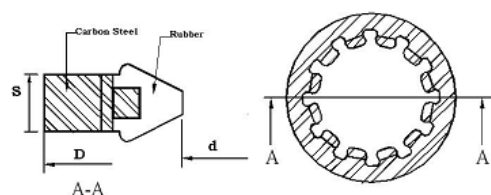

ID (d)	AD (D)	H (s)	Artikel
6.0	15.3	1.2	GMS4059
7.6	15.3	1.3	GMS4057
8.2	16.0	1.3	GMS4067
9.3	16.8	1.3	GMS4056
10.0	18.5	1.0	GMS4058
11.2	19.1	1.3	GMS4068
16.0	33.4	3.1	GMS4065

ID (d)	AD (D)	H (s)	Artikel
15.3	28.00	1.30	GMS4062
15.4	23.60	1.30	GMS4066
15.5	30.00	3.00	GMS4060
15.5	30.12	5.53	GMS4063
15.7	30.40	3.66	GMS4064
17.1	25.40	1.30	GMS4069
17.4	31.50	1.30	GMS4061

small is beautiful - Mikroverbundteile von Hoffmann

Selbstzentrierende Dichtscheibe mit Aussendichtung Typ UA
Bonded Seal Typ UA Sealing Washer

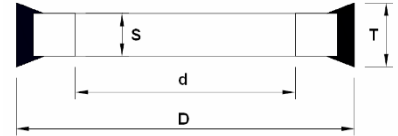

ID (d)	AD (D)	H (s)	Artikel
10.0	16.0	1.5	UA6005
10.2	16.0	1.5	UA6004
13.3	21.5	1.5	UA6001
16.0	22.0	1.5	UA6007

ID (d)	AD (D)	H (s)	Artikel
5.2	8.7	1.0	UA6006
6.2	10.0	1.0	UA6002
8.2	13.0	1.0	UA6003

Sonderanfertigungen / Bonded Seal - Other

ID (d)	AD (D)	H (s)	Artikel
20.00	33.22	1.50	BS9005

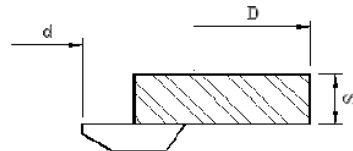

ID (d)	AD (D)	H (s)	Artikel
5.40	14.90	1.00	BS9007
5.10	14.90	1.00	BS9008
11.50	22.00	1.50	BS9004

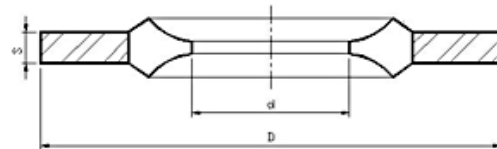

ID (d)	AD (D)	H (s)	Artikel
5.80	11.00	1.00	BS9003

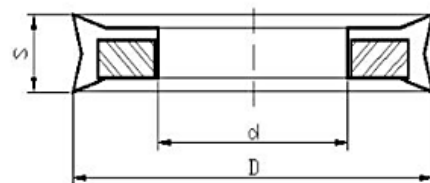

ID (d)	AD (D)	H (s)	Artikel
7.60	13.50	1.20	BS9002
15.80	22.50	2.00	BS9001

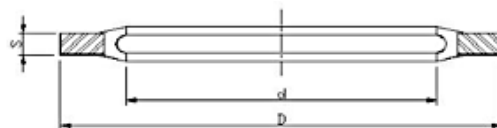

ID (d)	AD (D)	H (s)	Artikel
6.50	14.90	1.00	BS9011

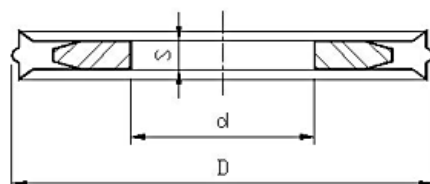

small is beautiful - Mikroverbundteile von Hoffmann



HOFFMANN

vor-teil. form. spezialitäten.

Sonderanfertigungen / Bonded Seal - Other

ID (d)	AD (D)	H (s)	Artikel
16.33	27.99	1.60	BS9014



ID (d)	AD (D)	H (s)	Artikel
7.40	17.08	2.80	BS9013

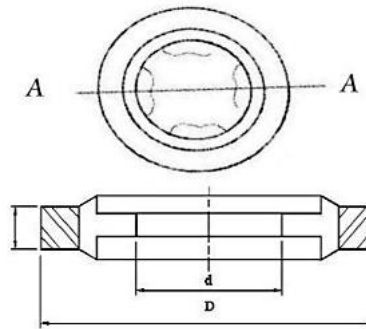

ID (d)	AD (D)	H (s)	Artikel
19.55	26.00	4.49	BS9016

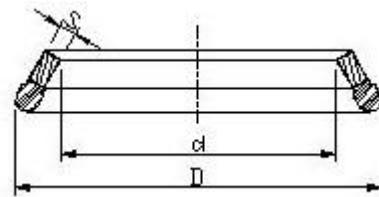

ID (d)	AD (D)	H (s)	Artikel
3.93	5.84	0.91	BS9015

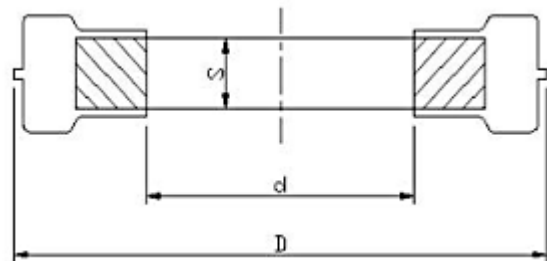

ID (d)	AD (D)	H (s)	Artikel
22.00	30.20	3.10	BS9009

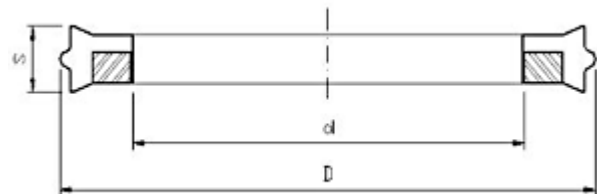

small is beautiful - Mikroverbundteile von Hoffmann